

Mid-Power LED - 3528 Series

S1W0-2835xx8003-00000000-0P006
(Cool, Neutral, Warm)

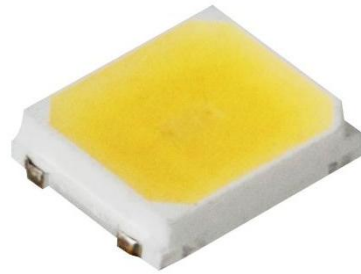

Product Brief

Description

- This White Colored surface-mount LED comes in standard package dimension. Package Size: 3.5x2.8x0.7mm
- It has a substrate made up of a molded plastic reflector sitting on top of a lead frame.
- The die is attached within the reflector cavity and the cavity is encapsulated by silicone.
- The package design coupled with careful selection of component materials allow these products to perform with high reliability.

Features and Benefits

- Market Standard 3528 Package Size
- High Color Quality, CRI Min. 80
- RoHS compliant

Key Applications

- Interior lighting
- General lighting
- Indoor and outdoor displays
- Architectural / Decorative lighting

Table 1. Product Selection Table

Reference Code	Color	Nominal CCT	Part Number	CRI
				Min
STW8A2PD-E1(H)	Cool White	6500K	S1W0-2835658003-00000000-0P006	80
		5700K	S1W0-2835578003-00000000-0P006	
		5000K	S1W0-2835508003-00000000-0P006	
	Neutral White	4000K	S1W0-2835408003-00000000-0P006	
		Warm White	3500K	
	3000K		S1W0-2835308003-00000000-0P006	
	2700K		S1W0-2835278003-00000000-0P006	

Table of Contents

Index		
•	Product Brief	1
•	Table of Contents	2
•	Performance Characteristics	3
•	Characteristics Graph	5
•	Color Bin Structure	11
•	Mechanical Dimensions	15
•	Recommended Solder Pad	16
•	Reflow Soldering Characteristics	17
•	Emitter Tape & Reel Packaging	18
•	Product Nomenclature	20
•	Handling of Silicone Resin for LEDs	21
•	Precaution For Use	22
•	Company Information	25

Performance Characteristics

Table 2. Product Selection Guide, $I_F = 65\text{mA}$, $T_j = 25^\circ\text{C}$, RH30%

Min. CRI, R _a	Nominal CCT [K] ^[1]	Min. Flux [lm]	Typ. Luminous Flux Φ_v ^[2] [lm] @65mA	Typ. Luminous Efficacy [lm/W] @65mA	Part Number
80	6500	34.2	36.1	203.9	S1W0-2835658003-00000000-0P006
	5700	34.2	36.4	205.8	S1W0-2835578003-00000000-0P006
	5000	35.2	36.9	208.7	S1W0-2835508003-00000000-0P006
	4000	35.2	36.9	208.7	S1W0-2835408003-00000000-0P006
	3500	34.2	35.4	199.9	S1W0-2835358003-00000000-0P006
	3000	32.5	35.0	198.1	S1W0-2835308003-00000000-0P006
	2700	32.5	34.0	192.2	S1W0-2835278003-00000000-0P006

Notes :

(1) Correlated Color Temperature is derived from the CIE 1931 Chromaticity diagram.

(2) Seoul Semiconductor maintains a tolerance of $\pm 7\%$ on Flux and power measurements.

The luminous Flux was measured at the peak of the spatial pattern which may not be aligned with the mechanical axis of the LED package.

Performance Characteristics

Table 3. Characteristics, $I_F=65\text{mA}$, $T_J= 25^\circ\text{C}$, RH30%

Parameter	Symbol	Value			Unit
		Min.	Typ.	Max.	
Forward Current	I_F	-	65	-	mA
Forward Voltage	V_F	-	2.72	2.9	V
CRI [3]	R_a	80	83	90	
Viewing Angle	$2\theta_{1/2}$	-	120	-	Deg.
Storage Temperature	T_{stg}	- 40	-	+ 85	$^\circ\text{C}$
Thermal resistance (J to S) [4]	$R\theta_{J-S}$	-	10	-	$^\circ\text{C/W}$
ESD Sensitivity(HBM)	-	Class 2 JESD22-A114-E			

Table 4. Absolute Maximum Ratings

Parameter	Symbol	Value	Unit
Forward Current	I_F	200	mA
Power Dissipation	P_D	1.0	W
Junction Temperature	T_j	125	$^\circ\text{C}$
Operating Temperature	T_{opr}	-40 ~ + 85	$^\circ\text{C}$
Storage Temperature	T_{stg}	-40 ~ + 100	$^\circ\text{C}$

Notes :

- (1) Seoul Semiconductor maintains a tolerance of $\pm 7\%$ on Flux and power measurements.
 - (2) Correlated Color Temperature is derived from the CIE 1931 Chromaticity diagram.
Color coordinate : ± 0.005 , CCT $\pm 5\%$ tolerance.
 - (3) Tolerance is ± 2.0 on CRI , ± 0.3 on VF measurements.
 - (4) Thermal resistance is junction to Solder.
 - (5) The products are sensitive to static electricity and must be carefully taken when handling products
- **Calculated performance values are for reference only.**
 - **All measurements were made under the standardized environment of Seoul Semiconductor.**

Characteristics Graph

Fig 1. Color Spectrum, $T_j = 25^\circ\text{C}$, $I_F = 65\text{mA}$

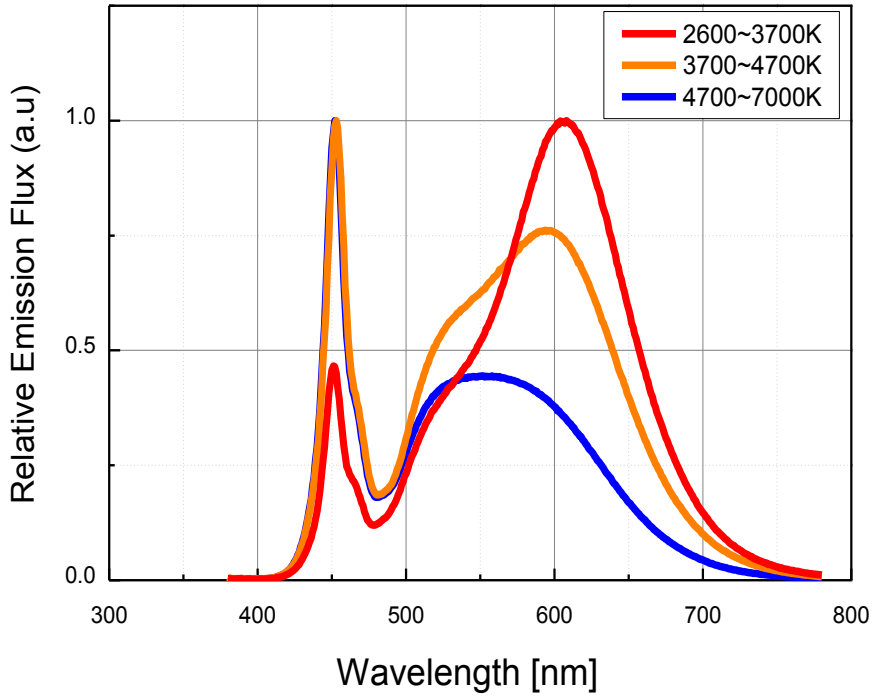
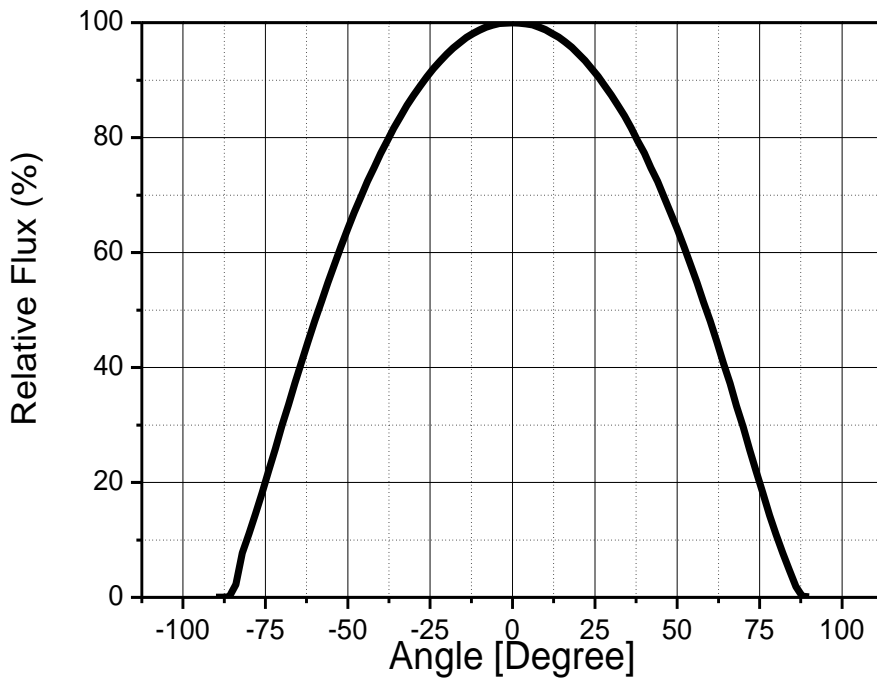

Fig 2. Radiant Pattern, $T_j = 25^\circ\text{C}$, $I_F = 65\text{mA}$



Characteristics Graph

Fig 3. Forward Voltage vs. Forward Current, $T_j = 25^\circ\text{C}$

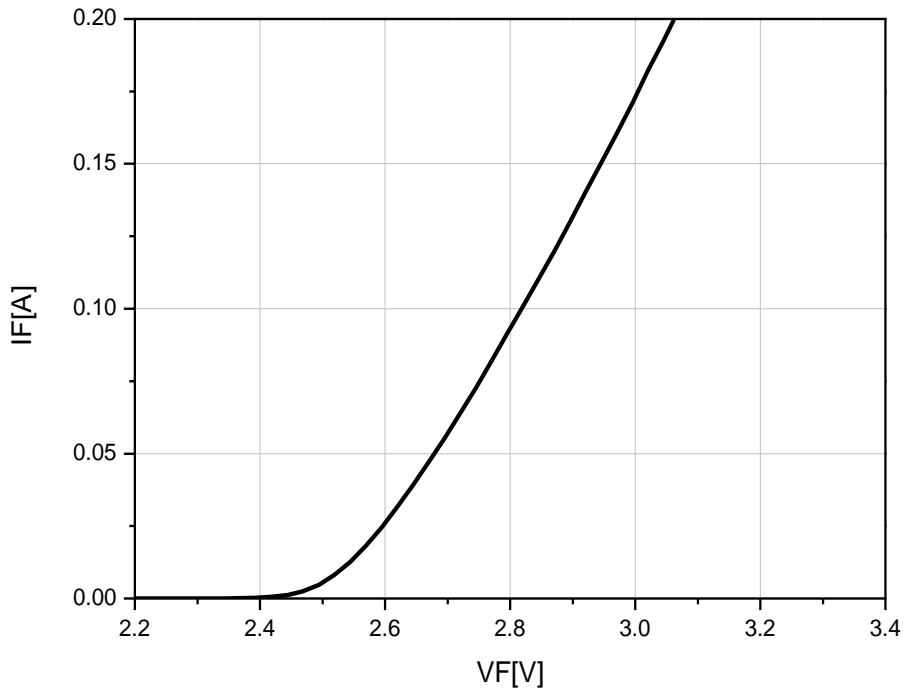
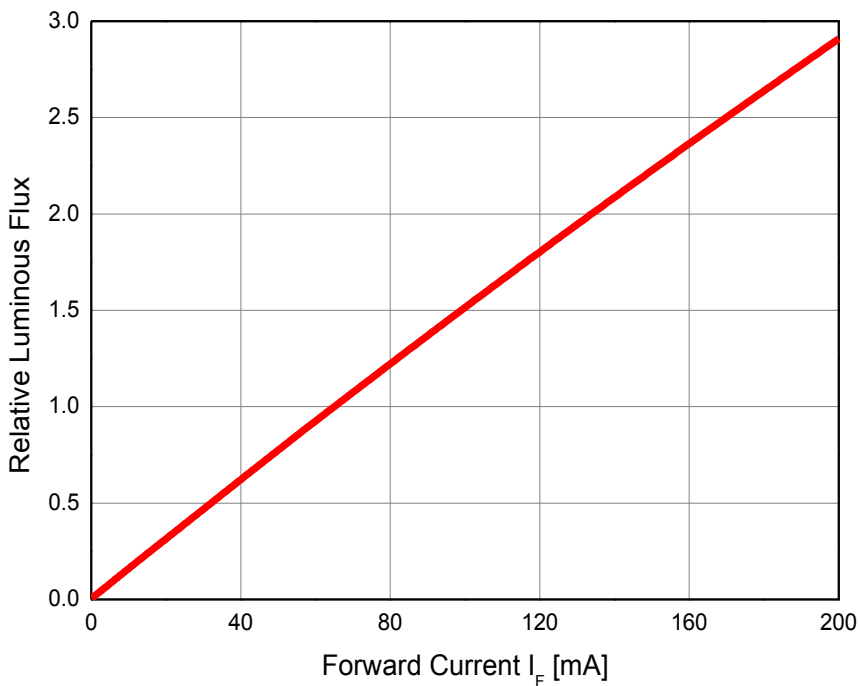
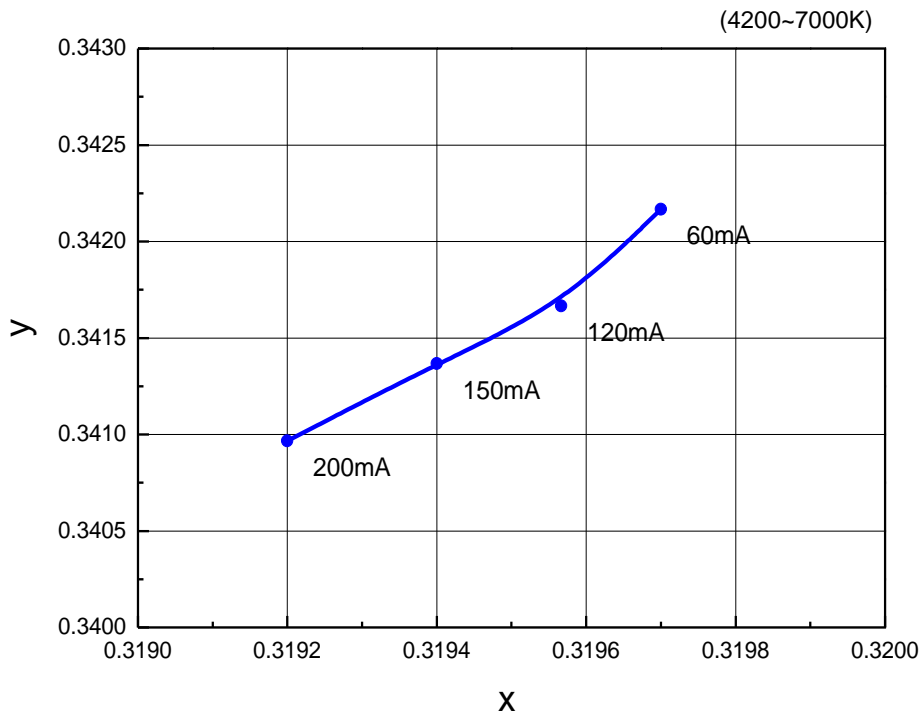
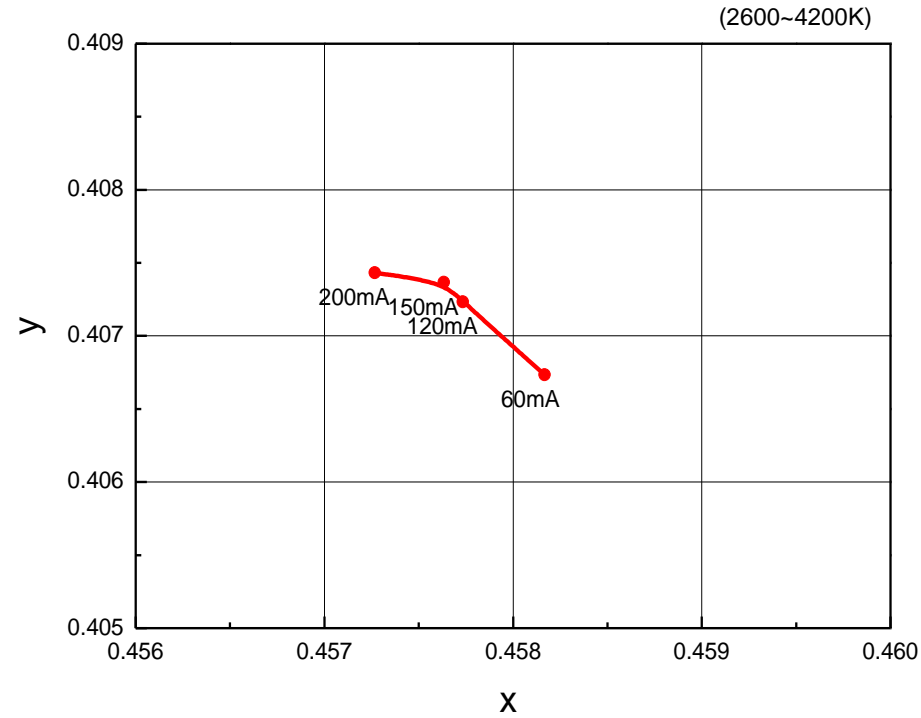

Fig 4. Forward Current vs. Relative Luminous Flux, $T_j = 25^\circ\text{C}$



Characteristics Graph

Fig 5. Forward Current vs. CIE X,Y Shift, $T_j = 25^\circ\text{C}$



Characteristics Graph

Fig 6. Junction Temperature vs. Relative Luminous Flux, $I_F=65\text{mA}$

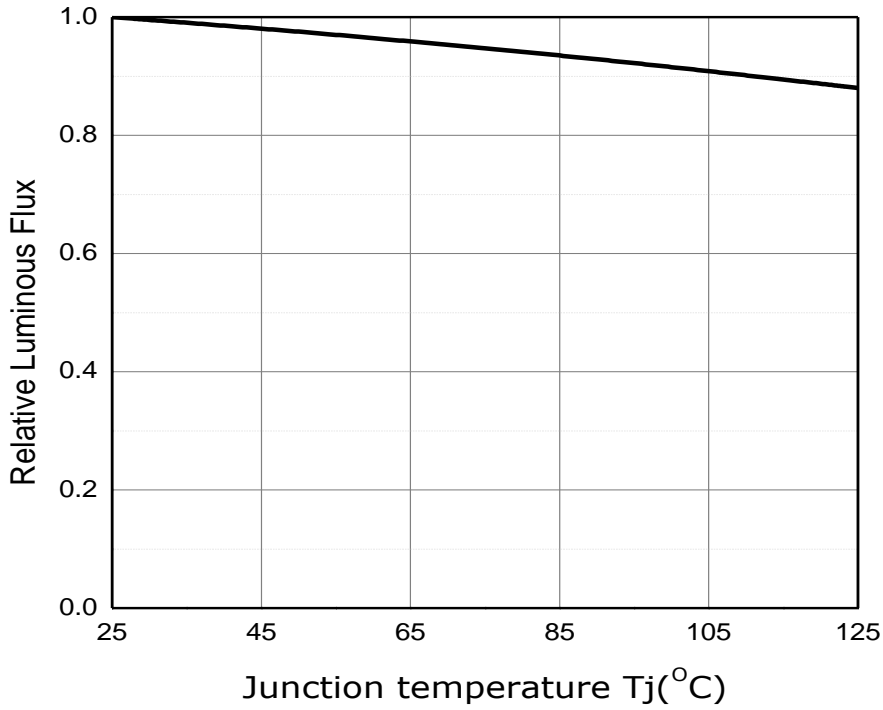
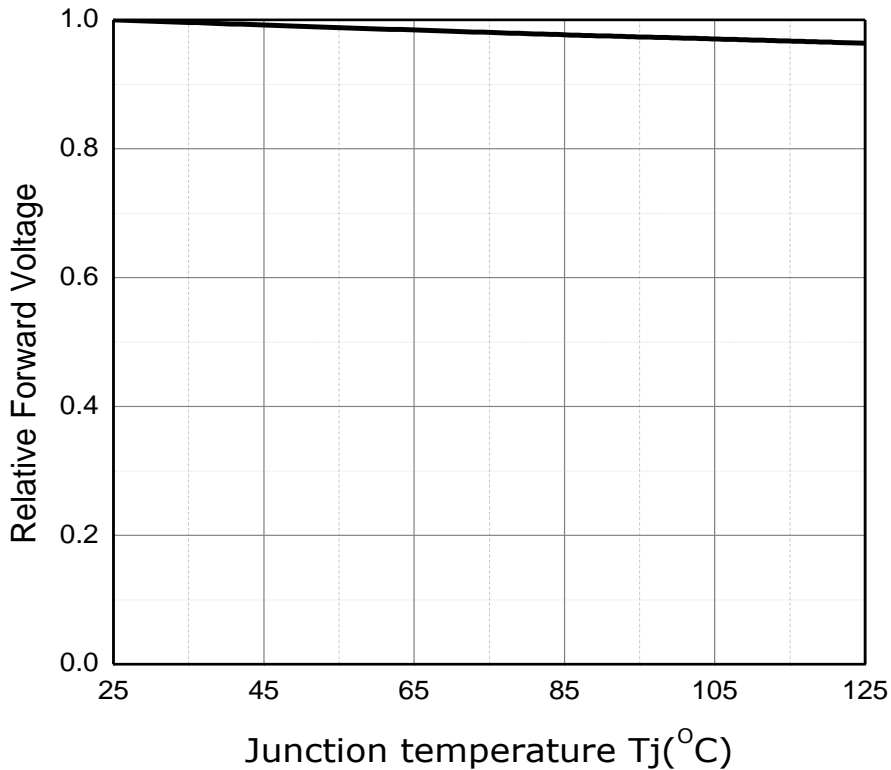
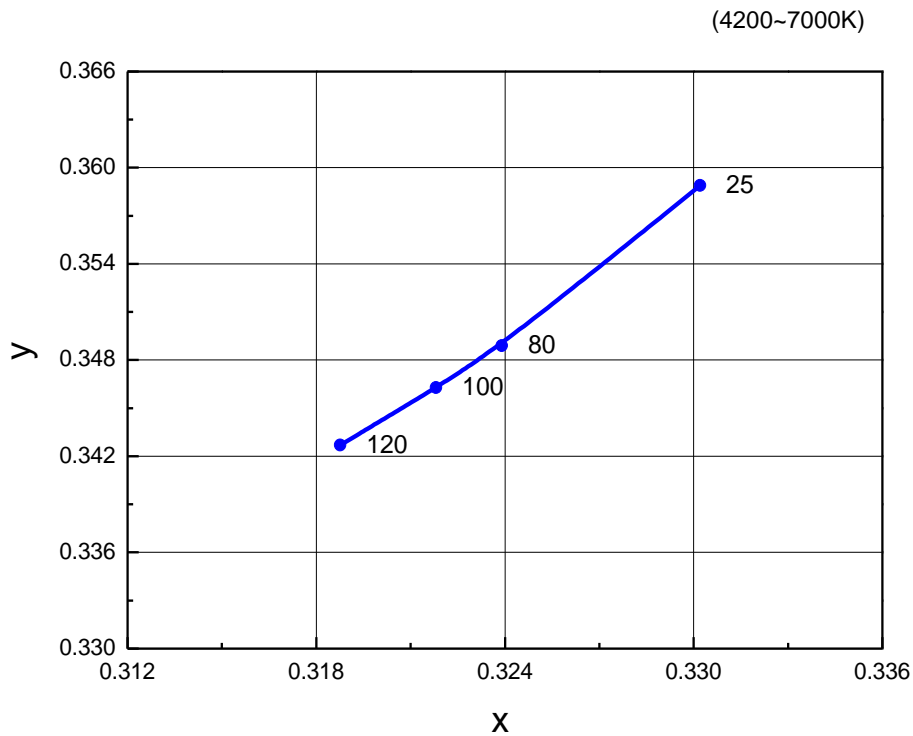
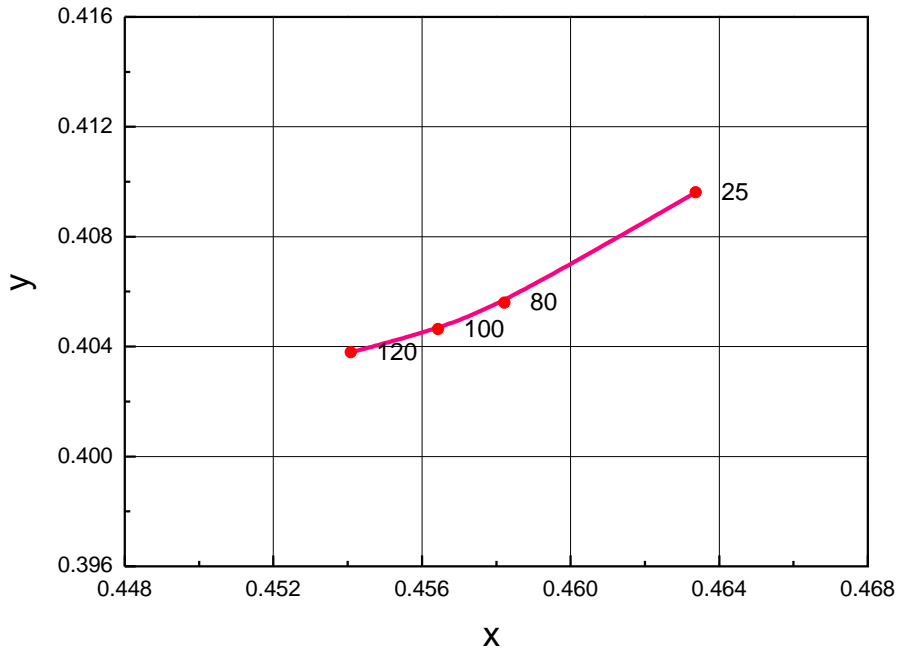

Fig 7. Junction Temperature vs. Relative Forward Voltage, $I_F=65\text{mA}$



Characteristics Graph

Fig 8. Chromaticity Coordinate vs. Junction Temperature, $I_F=65mA$
(2600~4200K)



Characteristics Graph

Fig 9. Ambient Temperature vs. Maximum Forward Current, $T_{j_max} = 125^{\circ}\text{C}$

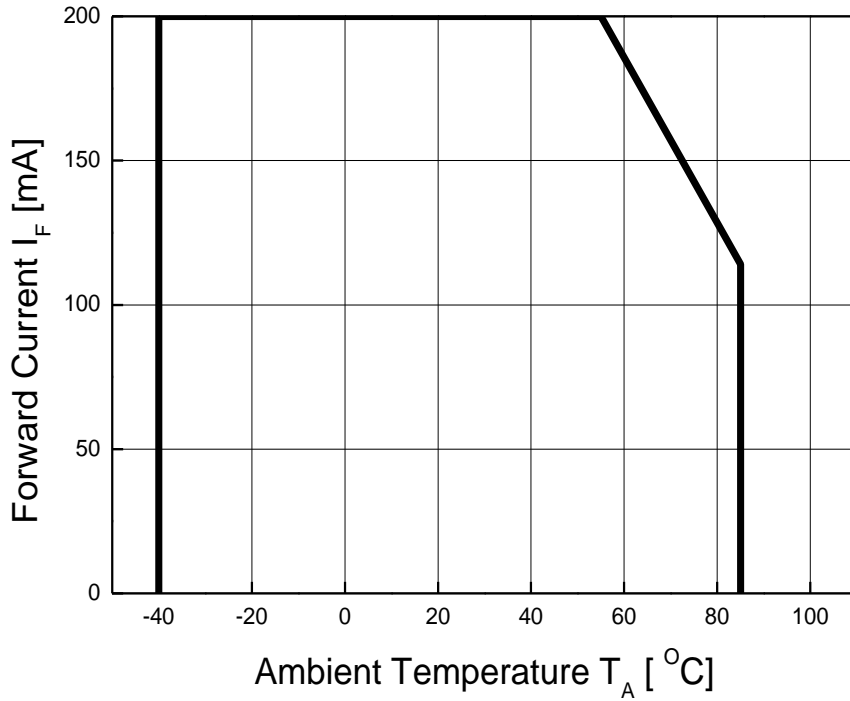

Color Bin Structure

Table 5. Bin Code description, $T_j=25^\circ\text{C}$, $I_f=65\text{mA}$

Part Number	Luminous Flux (lm)			Color Chromaticity Coordinate	Typical Forward Voltage (V)		
	Bin Code	Min.	Max.		Bin Code	Min.	Max.
S1W0-2835xx8003-00000000-0P006	U0	33.0	35.1	Refer to Page. 12	Y1L	2.68	2.73
	U3	33.9	35.1		Y1H	2.73	2.76
	U7	35.1	36.3				
	V1	36.3	37.2				
	V4	37.2	38.1				

Table 6. Flux rank distribution

Available ranks

CCT	CIE	Flux Rank				
6,000 ~ 7,000K	A	U0	U3	U7	V1	V4
5,300 ~ 6,000K	B	U0	U3	U7	V1	V4
4,700 ~ 5,300K	C	U0	U3	U7	V1	V4
3,700 ~ 4,200K	E	U0	U3	U7	V1	V4
3,200 ~ 3,700K	F	U0	U3	U7	V1	V4
2,900 ~ 3,200K	G	U0	U3	U7	V1	V4
2,600 ~ 2,900K	H	U0	U3	U7	V1	V4

***Notes :**

- All measurements were made under the standardized environment of Seoul Semiconductor. In order to ensure availability, single color rank will not be orderable.

Color Bin Structure

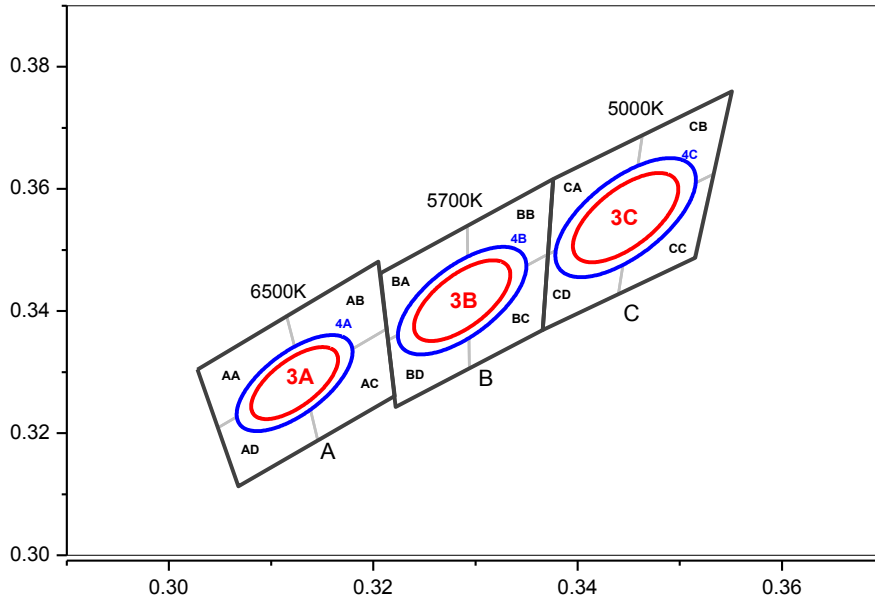
CIE Chromaticity Diagram $T_j=25^\circ\text{C}$, $I_f=65\text{mA}$

6500K 3Step		5700K 3Step		5000K 3Step	
3A		3B		3C	
Center point	0.3123 : 0.3282	Center point	0.3287 : 0.3417	Center point	0.3447 : 0.3553
Major Axis a	0.00669	Major Axis a	0.00746	Major Axis a	0.00822
Minor Axis b	0.00285	Minor Axis b	0.00320	Minor Axis b	0.00354
Ellipse	58.57	Ellipse	59.09	Ellipse	59.62
Rotation Angle		Rotation Angle		Rotation Angle	

6500K 4Step		5700K 4Step		5000K 4Step	
4A		4B		4C	
Center point	0.3123 : 0.3282	Center point	0.3287 : 0.3417	Center point	0.3447 : 0.3553
Major Axis a	0.00892	Major Axis a	0.00995	Major Axis a	0.01096
Minor Axis b	0.00380	Minor Axis b	0.00427	Minor Axis b	0.00472
Ellipse	58.57	Ellipse	59.09	Ellipse	59.62
Rotation Angle		Rotation Angle		Rotation Angle	

AA		AB		AC		AD	
CIE X	CIE Y	CIE X	CIE Y	CIE X	CIE Y	CIE X	CIE Y
0.3028	0.3304	0.3115	0.3393	0.3131	0.329	0.3048	0.3209
0.3048	0.3209	0.3131	0.329	0.3146	0.3187	0.3068	0.3113
0.3131	0.329	0.3213	0.3371	0.3221	0.3261	0.3146	0.3187
0.3115	0.3393	0.3205	0.3481	0.3213	0.3371	0.3131	0.329
BA		BB		BC		BD	
CIE X	CIE Y	CIE X	CIE Y	CIE X	CIE Y	CIE X	CIE Y
0.3207	0.3462	0.3292	0.3539	0.3293	0.3423	0.3215	0.3353
0.3215	0.3353	0.3293	0.3423	0.3294	0.3306	0.3222	0.3243
0.3293	0.3423	0.3371	0.3493	0.3366	0.3369	0.3294	0.3306
0.3292	0.3539	0.3376	0.3616	0.3371	0.3493	0.3293	0.3423
CA		CB		CC		CD	
CIE X	CIE Y	CIE X	CIE Y	CIE X	CIE Y	CIE X	CIE Y
0.3376	0.3616	0.3463	0.3687	0.3452	0.3558	0.3371	0.3493
0.3371	0.3493	0.3452	0.3558	0.344	0.3428	0.3366	0.3369
0.3452	0.3558	0.3533	0.3624	0.3514	0.3487	0.344	0.3428
0.3463	0.3687	0.3551	0.376	0.3533	0.3624	0.3452	0.3558

Color Bin Structure

CIE Chromaticity Diagram $T_j=25^\circ\text{C}$, $I_f=65\text{mA}$

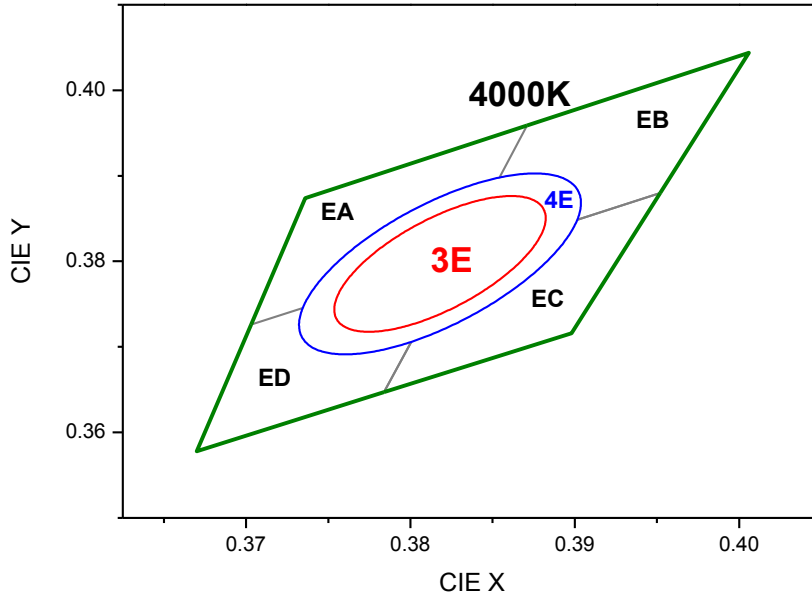

4000K 3Step

3E	
Center point	0.3818 : 0.3797
Major Axis a	0.00939
Minor Axis b	0.00402
Ellipse Rotation Angle	53.72

4000K 4Step

4E	
Center point	0.3818 : 0.3797
Major Axis a	0.01252
Minor Axis b	0.00536
Ellipse Rotation Angle	53.72

EA		EB		EC		ED	
CIE X	CIE Y	CIE X	CIE Y	CIE X	CIE Y	CIE X	CIE Y
0.3736	0.3874	0.3871	0.3959	0.3828	0.3803	0.3703	0.3726
0.3703	0.3726	0.3828	0.3803	0.3784	0.3647	0.367	0.3578
0.3828	0.3803	0.3952	0.388	0.3898	0.3716	0.3784	0.3647
0.3871	0.3959	0.4006	0.4044	0.3952	0.388	0.3828	0.3803

Color Bin Structure

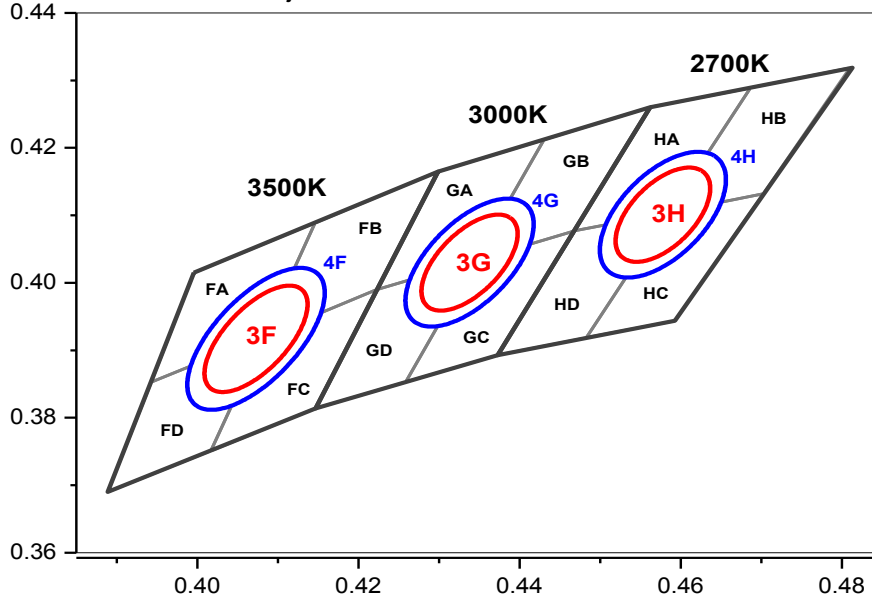
CIE Chromaticity Diagram $T_j=25^\circ\text{C}$, $I_f=65\text{mA}$

3500K 3Step		3000K 3Step		2700K 3Step	
3 Step		3 Step		3 Step	
Center point	0.4073 : 0.3917	Center point	0.4338 : 0.4030	Center point	0.4578 : 0.4101
Major Axis a	0.00927	Major Axis a	0.00834	Major Axis a	0.00810
Minor Axis b	0.00414	Minor Axis b	0.00408	Minor Axis b	0.00420
Ellipse	54.00	Ellipse	53.22	Ellipse	53.70
Rotation Angle		Rotation Angle		Rotation Angle	

3500K 4Step		3000K 4Step		2700K 4Step	
4 Step		4 Step		4 Step	
Center point	0.4073 : 0.3917	Center point	0.4338 : 0.4030	Center point	0.4578 : 0.4101
Major Axis a	0.01236	Major Axis a	0.01112	Major Axis a	0.01080
Minor Axis b	0.00552	Minor Axis b	0.00544	Minor Axis b	0.00560
Ellipse	54.00	Ellipse	53.22	Ellipse	53.70
Rotation Angle		Rotation Angle		Rotation Angle	

FA		FB		FC		FD	
CIE X	CIE Y	CIE X	CIE Y	CIE X	CIE Y	CIE X	CIE Y
0.3996	0.4015	0.4146	0.4089	0.4082	0.392	0.3943	0.3853
0.3943	0.3853	0.4082	0.392	0.4017	0.3751	0.3889	0.369
0.4082	0.392	0.4223	0.399	0.4147	0.3814	0.4017	0.3751
0.4146	0.4089	0.4299	0.4165	0.4223	0.399	0.4082	0.392
GA		GB		GC		GD	
CIE X	CIE Y	CIE X	CIE Y	CIE X	CIE Y	CIE X	CIE Y
0.4299	0.4165	0.443	0.4212	0.4345	0.4033	0.4223	0.399
0.4223	0.399	0.4345	0.4033	0.4259	0.3853	0.4147	0.3814
0.4345	0.4033	0.4468	0.4077	0.4373	0.3893	0.4259	0.3853
0.443	0.4212	0.4562	0.426	0.4468	0.4077	0.4345	0.4033
HA		HB		HC		HD	
CIE X	CIE Y	CIE X	CIE Y	CIE X	CIE Y	CIE X	CIE Y
0.4562	0.426	0.4687	0.4289	0.4585	0.4104	0.4468	0.4077
0.4468	0.4077	0.4585	0.4104	0.4483	0.3919	0.4373	0.3893
0.4585	0.4104	0.4703	0.4132	0.4593	0.3944	0.4483	0.3919
0.4687	0.4289	0.481	0.4319	0.4703	0.4132	0.4585	0.4104

Mechanical Dimensions

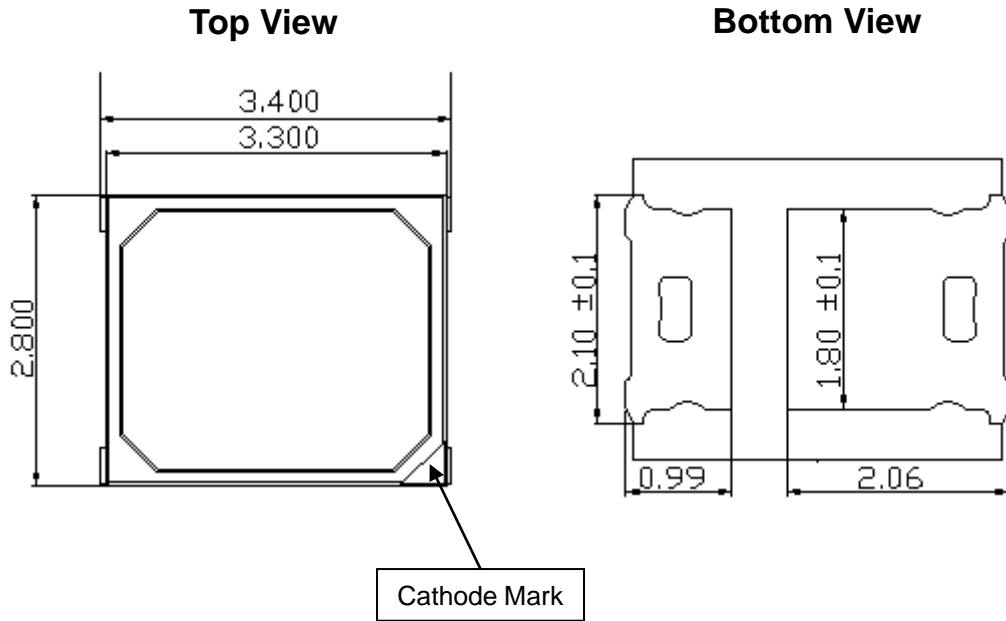

Side View

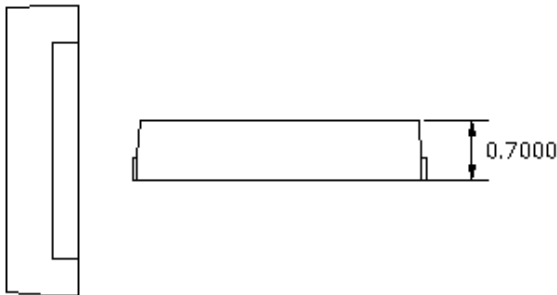

Notes :

- (1) All dimensions are in millimeters.
- (2) Scale : none
- (3) Undefined tolerance is ± 0.2 mm

Recommended Solder Pad

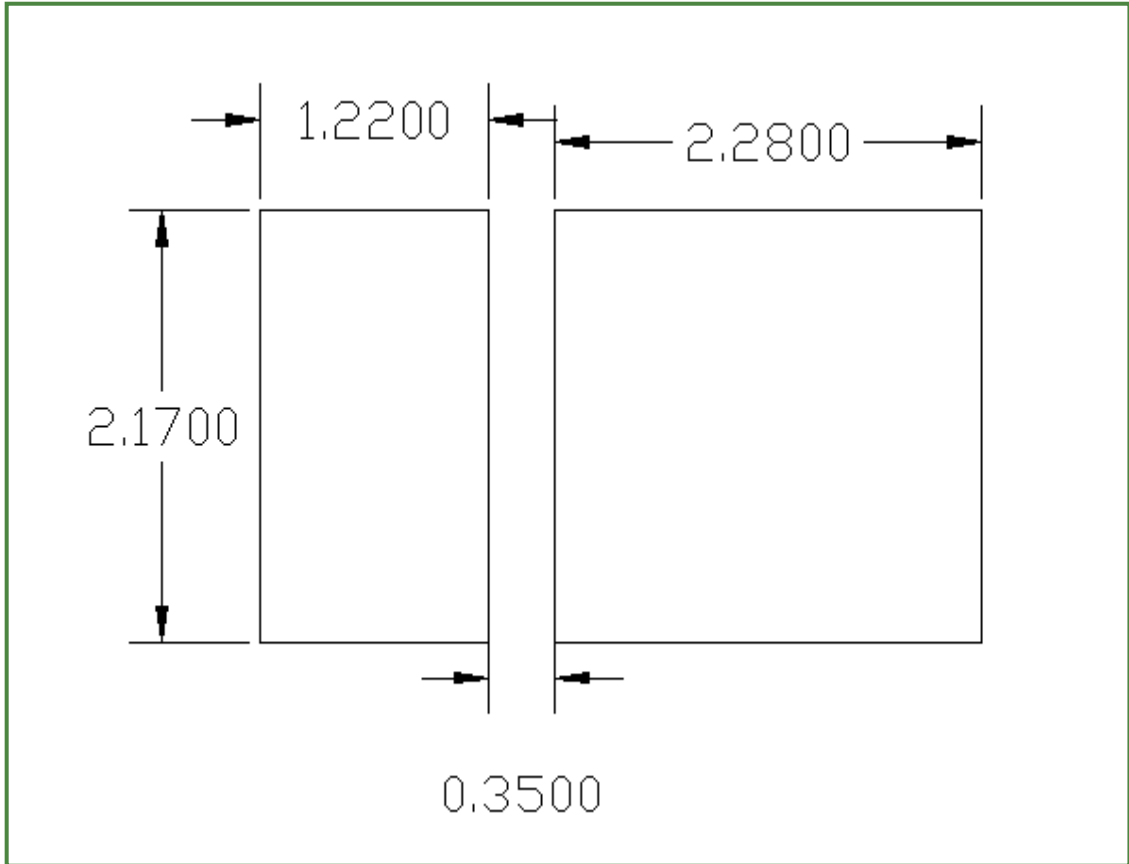
Notes :

- (1) All dimensions are in millimeters.
- (2) Scale : none
- (3) This drawing without tolerances are for reference only
- (4) Undefined tolerance is $\pm 0.1\text{mm}$
- (5) The appearance and specifications of the product may be changed for improvement without notice.

Reflow Soldering Characteristics

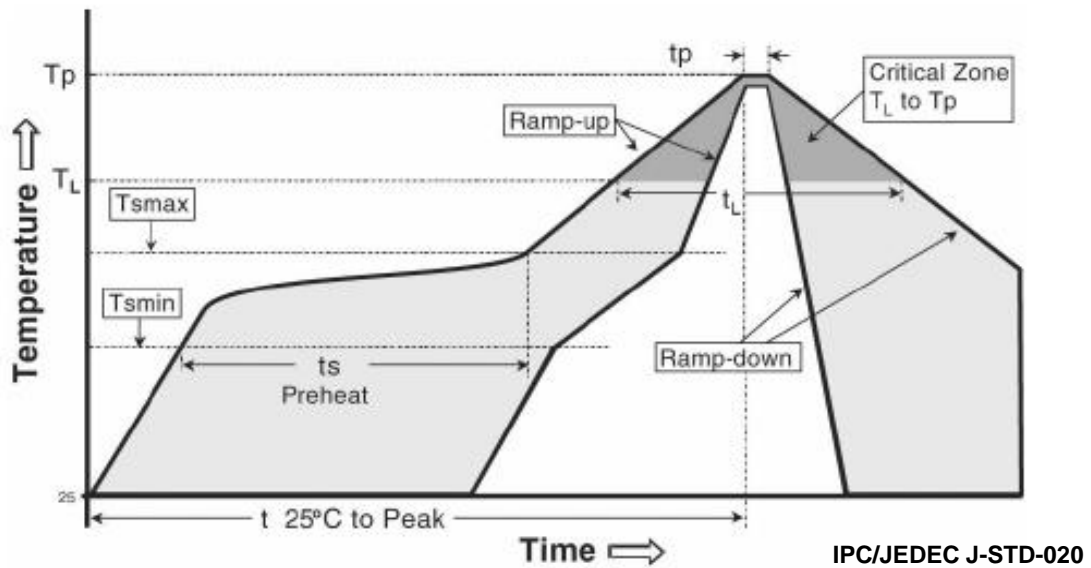

Profile Feature	Sn-Pb Eutectic Assembly	Pb-Free Assembly
Average ramp-up rate (T_{s_max} to T_p)	3° C/second max.	3° C/second max.
Preheat - Temperature Min (T_{s_min}) - Temperature Max (T_{s_max}) - Time (T_{s_min} to T_{s_max}) (t_s)	100 °C 150 °C 60-120 seconds	150 °C 200 °C 60-180 seconds
Time maintained above: - Temperature (T_L) - Time (t_L)	183 °C 60-150 seconds	217 °C 60-150 seconds
Peak Temperature (T_p)	215 °C	260 °C
Time within 5°C of actual Peak Temperature (t_p) ²	10-30 seconds	20-40 seconds
Ramp-down Rate	6 °C/second max.	6 °C/second max.
Time 25°C to Peak Temperature	6 minutes max.	8 minutes max.

Caution :

- (1) Reflow soldering is recommended not to be done more than two times
In the case of more than 24 hours passed soldering after first, LEDs will be damaged.
- (2) Repairs should not be done after the LEDs have been soldered
When repair is unavoidable, suitable tools must be used.
- (3) Die slug is to be soldered.
- (4) When soldering, do not put stress on the LEDs during heating.
- (5) After soldering, do not warp the circuit board.

Emitter Tape & Reel Packaging

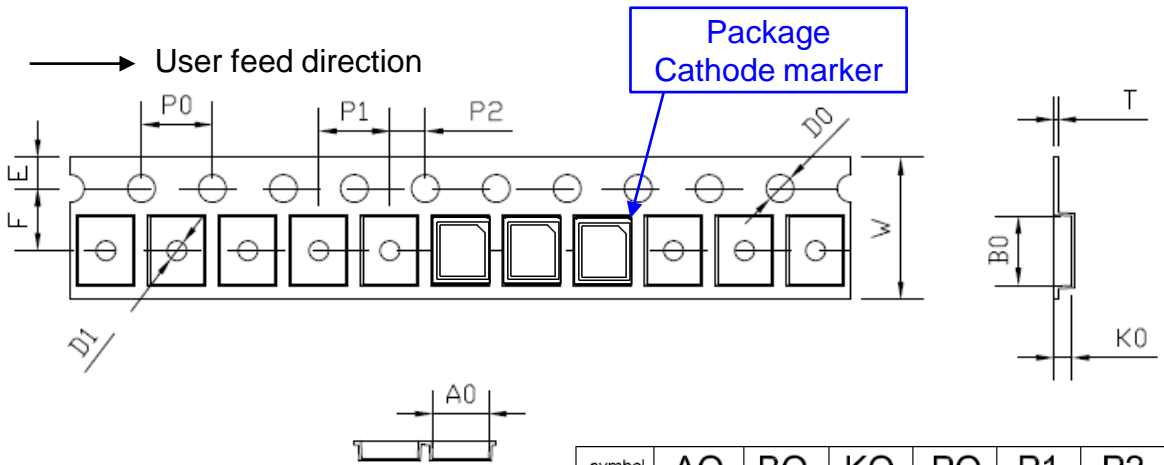

symbol	AO	BO	KO	PO	P1	P2
Spec	3.0±0.10	3.75±0.15	1.05±0.15	4.0±0.10	4.0±0.10	2.0±0.10
symbol	W	T	E	F	DO	D1
Spec	8.00±0.10	0.20±0.05	1.75±0.10	3.5±0.10	1.5±0.05	1.10±0.10

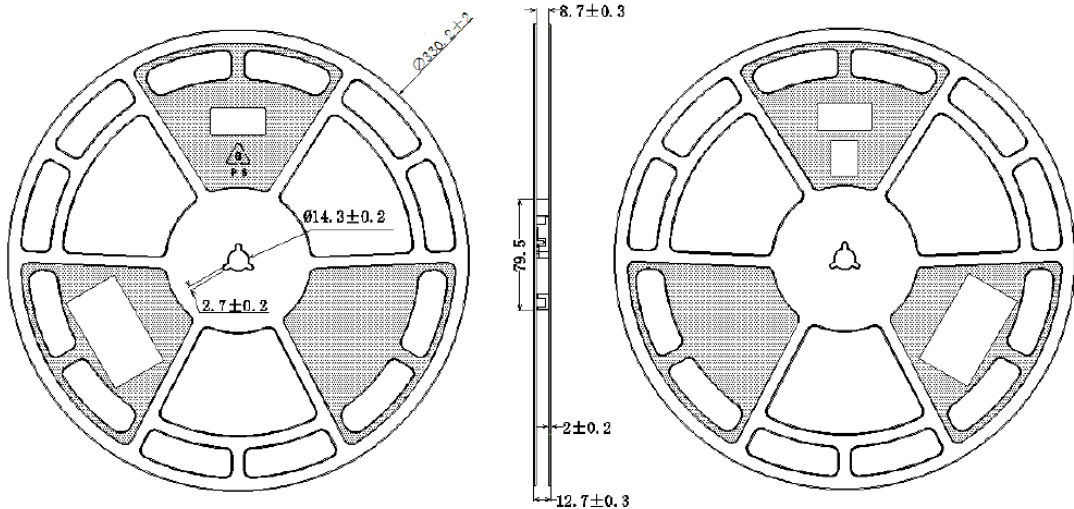

Notes :

- (1) Quantity : Max 16,000pcs/Reel
- (2) Cumulative Tolerance : Cumulative Tolerance/10 pitches to be $\pm 0.2\text{mm}$
- (3) Adhesion Strength of Cover Tape
Adhesion strength to be 0.1-0.7N when the cover tape is turned off from the carrier tape at the angle of 10° to the carrier tape.
- (4) Package : P/N, Manufacturing data Code No. and Quantity to be indicated on a damp proof Package.

Emitter Tape & Reel Packaging

Reel

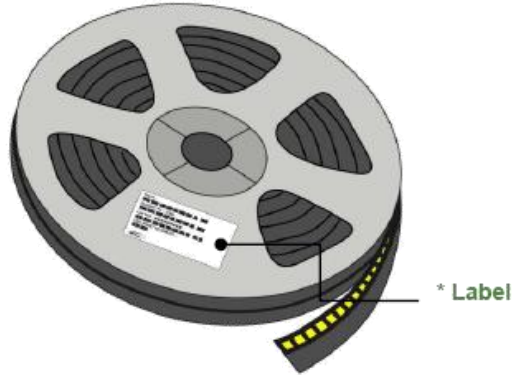

Aluminum Bag

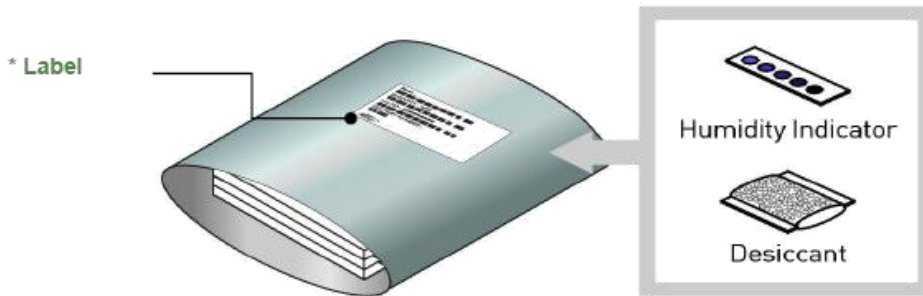

Outer Box

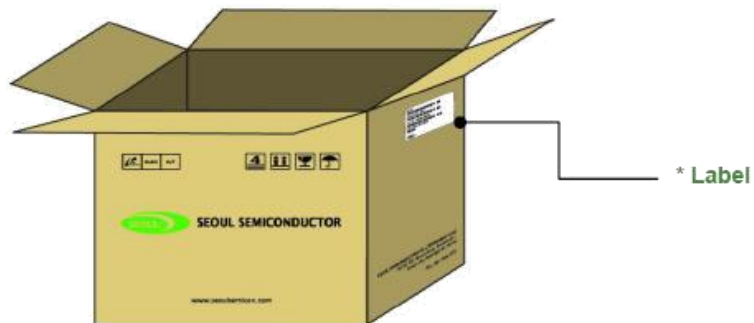

Product Nomenclature

Table 7. Part Numbering System

Part Number Code	Description	Part Number	Value
X ₁	Company	S	Seoul Semiconductor
X ₂	Level of Integration	1	Discrete LED
X ₃ X ₄	Technology	W0	General White
X ₅ X ₆ X ₇ X ₈	Dimension	2835	
X ₉ X ₁₀	CCT	xx	
X ₁₁ X ₁₂	CRI	80	
X ₁₃ X ₁₄	Vf	03	
X ₁₅ X ₁₆ X ₁₇	Characteristic code Flux Rank	000	
X ₁₈ X ₁₉ X ₂₀	Characteristic code Vf Rank	000	
X ₂₁ X ₂₂	Characteristic code Color Step	00	
X ₂₃ X ₂₄	Type	0P	
X ₂₅ X ₂₆ X ₂₇	Internal code	006	

Handling of Silicone Resin for LEDs

(1) During processing, mechanical stress on the surface should be minimized as much as possible. Sharp objects of all types should not be used to pierce the sealing compound.



(2) In general, LEDs should only be handled from the side. By the way, this also applies to LEDs without a silicone sealant, since the surface can also become scratched.

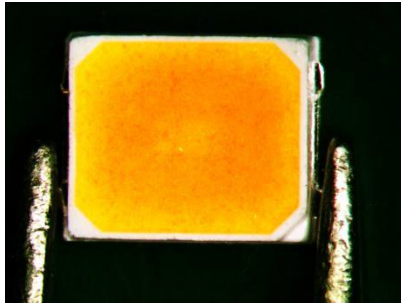

(3) When populating boards in SMT production, there are basically no restrictions regarding the form of the pick and place nozzle, except that mechanical pressure on the surface of the resin must be prevented. This is assured by choosing a pick and place nozzle which is larger than the LED's reflector area.

(4) Silicone differs from materials conventionally used for the manufacturing of LEDs. These conditions must be considered during the handling of such devices. Compared to standard encapsulants, silicone is generally softer, and the surface is more likely to attract dust.

As mentioned previously, the increased sensitivity to dust requires special care during processing. In cases where a minimal level of dirt and dust particles cannot be guaranteed, a suitable cleaning solution must be applied to the surface after the soldering of components.

(5) SSC suggests using isopropyl alcohol for cleaning. In case other solvents are used, it must be assured that these solvents do not dissolve the package or resin.

Ultrasonic cleaning is not recommended. Ultrasonic cleaning may cause damage to the LED.

(6) Please do not mold this product into another resin (epoxy, urethane, etc) and do not handle this product with acid or sulfur material in sealed space.

Precaution for Use

(1) Storage

To avoid the moisture penetration, we recommend store in a dry box with a desiccant.

The maximum storage temperature range is 40℃ and a maximum humidity of RH90%.

(2) Use Precaution after Opening the Packaging

Use SMT techniques properly when the LED is to be soldered dipped as separation of the lens may affect the light output efficiency.

Pay attention to the following:

a. Recommend conditions after opening the package

- Sealing

- Temperature : 30℃ Humidity : less than RH60%

b. If the package has been opened more than 4 week(MSL_2a) or the color of the desiccant changes, components should be dried for 10-24hr at 65±5℃

(3) Do not apply mechanical force or excess vibration during the cooling process to normal temperature after soldering.

(4) Do not rapidly cool device after soldering.

(5) Components should not be mounted on warped (non coplanar) portion of PCB.

(6) Radioactive exposure is not considered for the products listed here in.

(7) Gallium arsenide is used in some of the products listed in this publication.

These products are dangerous if they are burned or shredded in the process of disposal.

It is also dangerous to drink the liquid or inhale the gas generated by such products when chemically disposed of.

(8) This device should not be used in any type of fluid such as water, oil, organic solvent and etc.

When washing is required, IPA (Isopropyl Alcohol) should be used.

(9) When the LEDs are in operation the maximum current should be decided after measuring the package temperature.

Precaution for Use

- (10) The appearance and specifications of the product may be modified for improvement without notice.
- (11) Long time exposure of sunlight or occasional UV exposure will cause lens discoloration.
- (12) VOCs (Volatile organic compounds) emitted from materials used in the construction of fixtures can penetrate silicone encapsulants of LEDs and discolor when exposed to heat and photonic energy. The result can be a significant loss of light output from the fixture. Knowledge of the properties of the materials selected to be used in the construction of fixtures can help prevent these issues.
- (13) Attaching LEDs, do not use adhesives that outgas organic vapor.
- (14) The driving circuit must be designed to allow forward voltage only when it is ON or OFF.
If the reverse voltage is applied to LED, migration can be generated resulting in LED damage.
- (15) Similar to most Solid state devices;
LEDs are sensitive to Electro-Static Discharge (ESD) and Electrical Over Stress (EOS).
Below is a list of suggestions that Seoul Semiconductor purposes to minimize these effects.

a. ESD (Electro Static Discharge)

Electrostatic discharge (ESD) is defined as the release of static electricity when two objects come into contact. While most ESD events are considered harmless, it can be an expensive problem in many industrial environments during production and storage. The damage from ESD to LEDs may cause the product to demonstrate unusual characteristics such as:

- Increase in reverse leakage current lowered turn-on voltage
- Abnormal emissions from the LED at low current

The following recommendations are suggested to help minimize the potential for an ESD event. One or more recommended work area suggestions:

- Ionizing fan setup
- ESD table/shelf mat made of conductive materials
- ESD safe storage containers

One or more personnel suggestion options:

- Antistatic wrist-strap
- Antistatic material shoes
- Antistatic clothes

Environmental controls:

- Humidity control (ESD gets worse in a dry environment)

Precaution for Use

b. EOS (Electrical Over Stress)

Electrical Over-Stress (EOS) is defined as damage that may occur when an electronic device is subjected to a current or voltage that is beyond the maximum specification limits of the device. The effects from an EOS event can be noticed through product performance like:

- Changes to the performance of the LED package
(If the damage is around the bond pad area and since the package is completely encapsulated the package may turn on but flicker show severe performance degradation.)
- Changes to the light output of the luminaire from component failure
- Components on the board not operating at determined drive power

Failure of performance from entire fixture due to changes in circuit voltage and current across total circuit causing trickle down failures. It is impossible to predict the failure mode of every LED exposed to electrical overstress as the failure modes have been investigated to vary, but there are some common signs that will indicate an EOS event has occurred:

- Damaged may be noticed to the bond wires (appearing similar to a blown fuse)
- Damage to the bond pads located on the emission surface of the LED package
(shadowing can be noticed around the bond pads while viewing through a microscope)
- Anomalies noticed in the encapsulation and phosphor around the bond wires.
- This damage usually appears due to the thermal stress produced during the EOS event.

c. To help minimize the damage from an EOS event Seoul Semiconductor recommends utilizing:

- A surge protection circuit
- An appropriately rated over voltage protection device
- A current limiting device



Company Information

Published by

Seoul Semiconductor © 2013 All Rights Reserved.

Company Information

Seoul Semiconductor (www.SeoulSemicon.com) manufactures and packages a wide selection of light emitting diodes (LEDs) for the automotive, general illumination/lighting, Home appliance, signage and back lighting markets. The company is the world's fifth largest LED supplier, holding more than 10,000 patents globally, while offering a wide range of LED technology and production capacity in areas such as "nPola", "Acrich", the world's first commercially produced AC LED, and "Acrich MJT - Multi-Junction Technology" a proprietary family of high-voltage LEDs.

The company's broad product portfolio includes a wide array of package and device choices such as Acrich and Acirch2, high-brightness LEDs, mid-power LEDs, side-view LEDs, and through-hole type LEDs as well as custom modules, displays, and sensors.

Legal Disclaimer

Information in this document is provided in connection with Seoul Semiconductor products. With respect to any examples or hints given herein, any typical values stated herein and/or any information regarding the application of the device, Seoul Semiconductor hereby disclaims any and all warranties and liabilities of any kind, including without limitation, warranties of non-infringement of intellectual property rights of any third party. The appearance and specifications of the product can be changed to improve the quality and/or performance without notice.